

Cable Lead

USER MANUAL

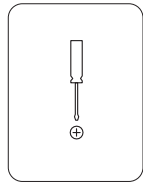

Components

Phillips Washer Head Self Tapping Screw (4)

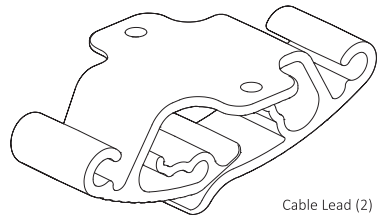

Cable Lead (2)

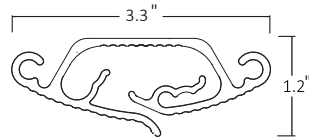

WARNING: When installing and using the product, act with care not to over bend to prevent breakage.

STEP 1 : Choose the most desirable place for the Cable Lead.

STEP 2 : Take two screws and screw the Cable Lead onto the underside of your desk.

STEP 3 : Place the cables through the opening on the Cable Lead and push them into the canals of the Cable Lead.

STEP 4 : You can use the canals on the left and the right side of the Cable Lead.

NOTE : See the other side of this page how you can use the Cable Lead in many different Wire Management arrangements.

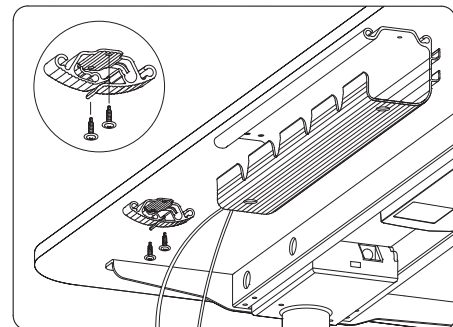
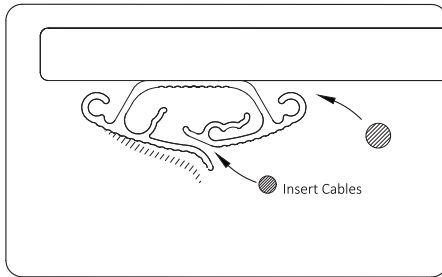

WARNING: To be installed on Desk Tops with a minimum thickness of 3/4"

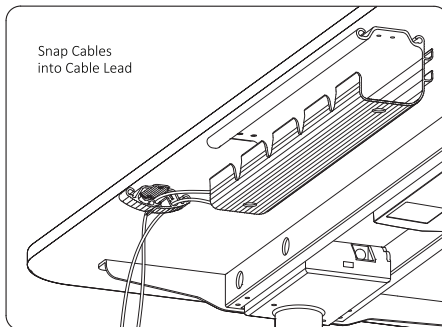

Cable Lead

USER MANUAL

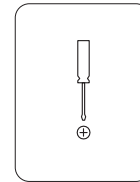

Components

Phillips Washer Head Self Tapping Screw (4)

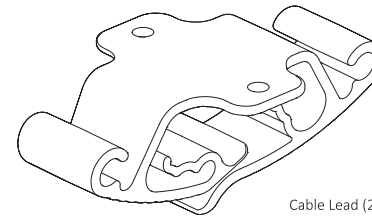

Cable Lead (2)

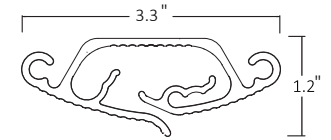

WARNING: When installing and using the product, act with care not to over bend to prevent breakage.

STEP 1 : Choose the most desirable place for the Cable Lead.

STEP 2 : Take two screws and screw the Cable Lead onto the underside of your desk.

STEP 3 : Place the cables through the opening on the Cable Lead and push them into the canals of the Cable Lead.

STEP 4 : You can use the canals on the left and the right side of the Cable Lead.

NOTE : See the other side of this page how you can use the Cable Lead in many different Wire Management arrangements.

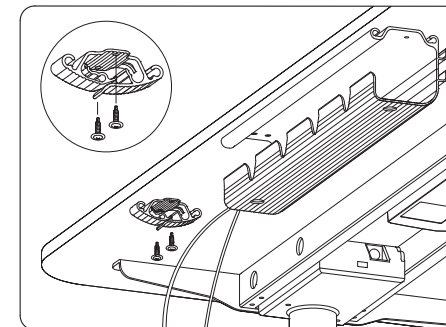
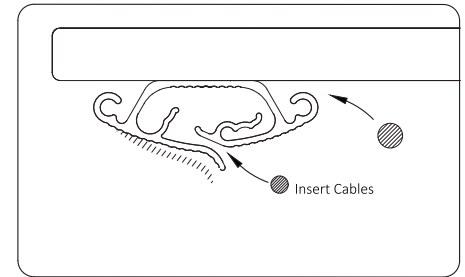

WARNING: To be installed on Desk Tops with a minimum thickness of 3/4"

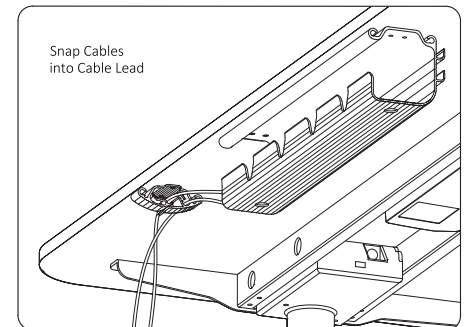

Sample Applications



From a desk wire management Tray to a Cable conduit.



From a desk wire management Tray to a Mesh tube.



Securing cables from point A to point B.



Secure cables from a side desk to a main desk.



Training Room, managing cables from desk to desk.



Meeting Table, managing cables from table to floor.

Sample Applications



From a desk wire management Tray to a Cable conduit.



From a desk wire management Tray to a Mesh tube.



Securing cables from point A to point B.



Secure cables from a side desk to a main desk.



Training Room, managing cables from desk to desk.



Meeting Table, managing cables from table to floor.